

20.75.1702.00

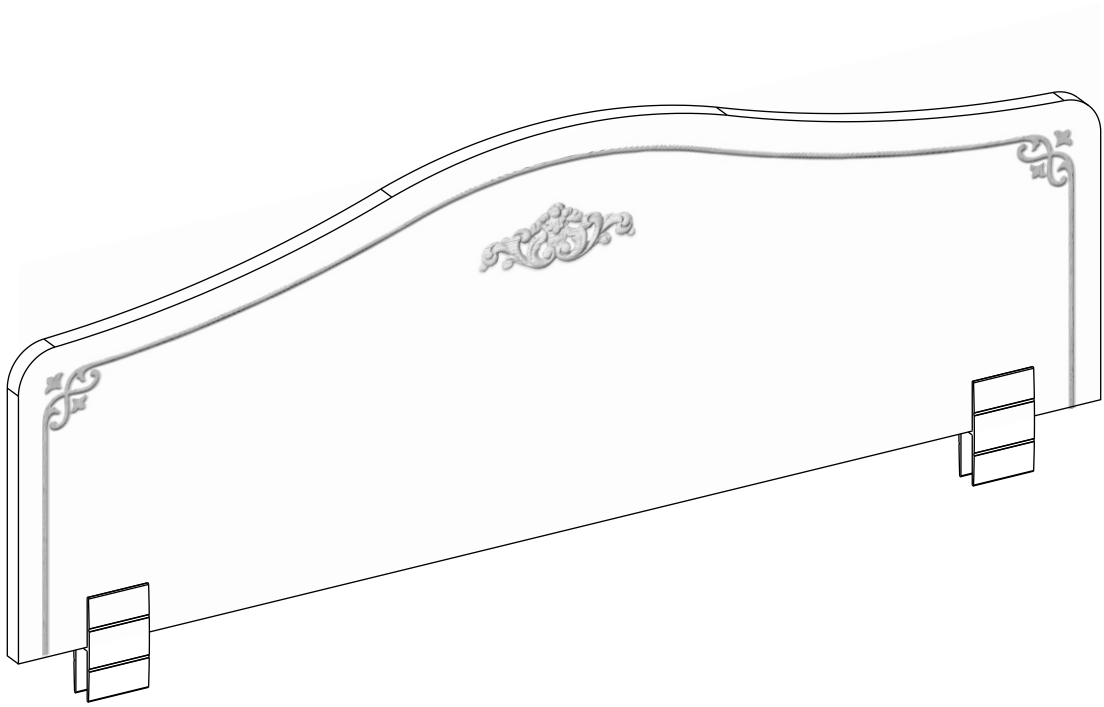

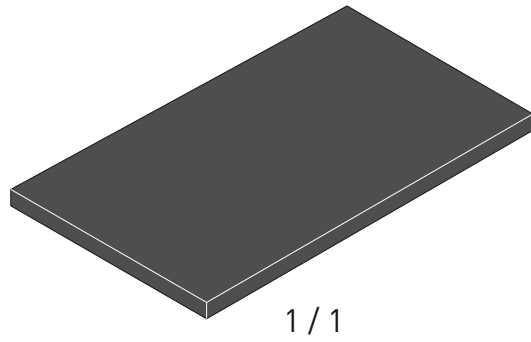

1 / 1

1 / 1

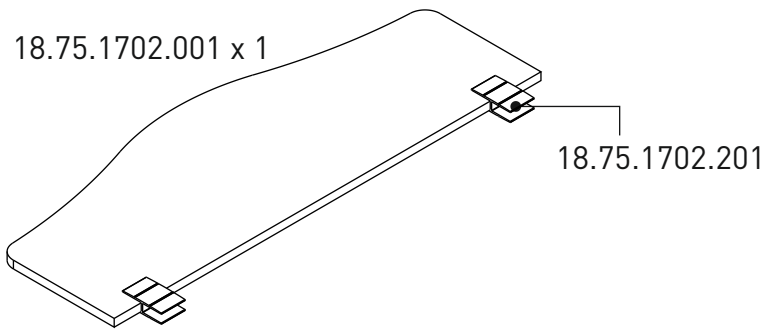

20.75.1702.00

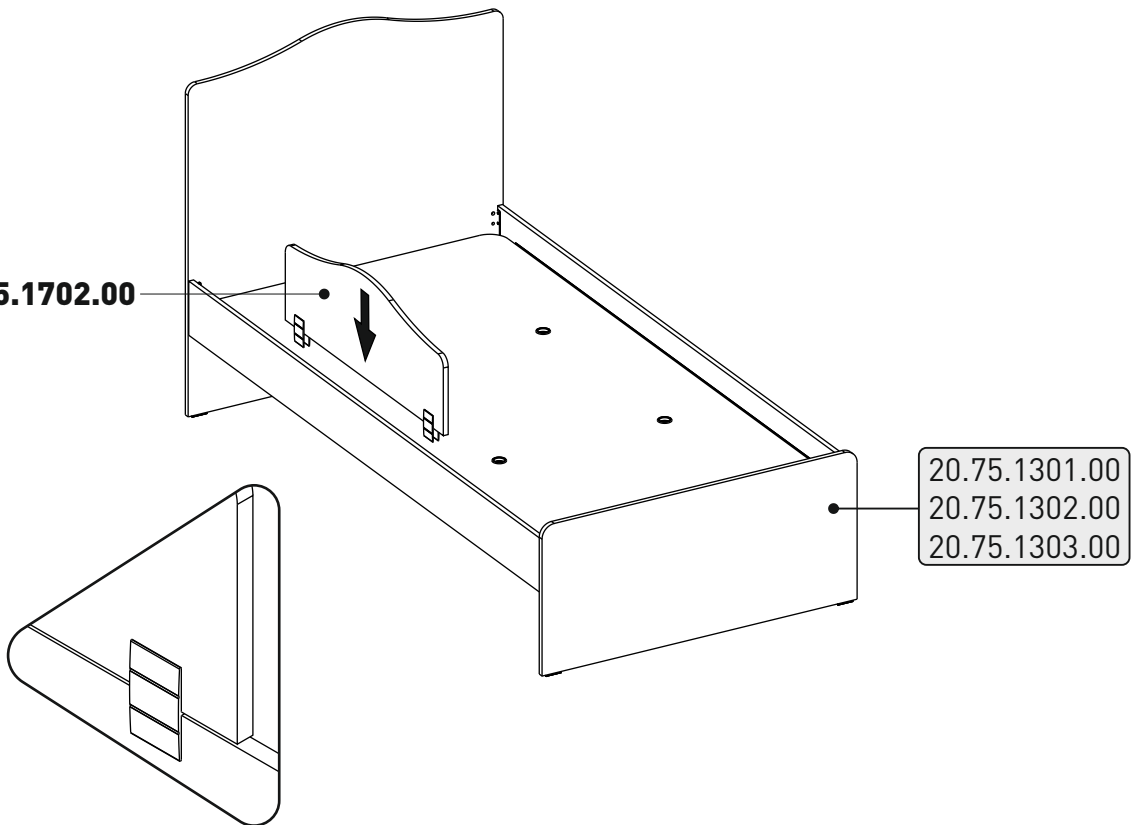

20.75.1301.00
20.75.1302.00
20.75.1303.00